

Piñones *Martin*

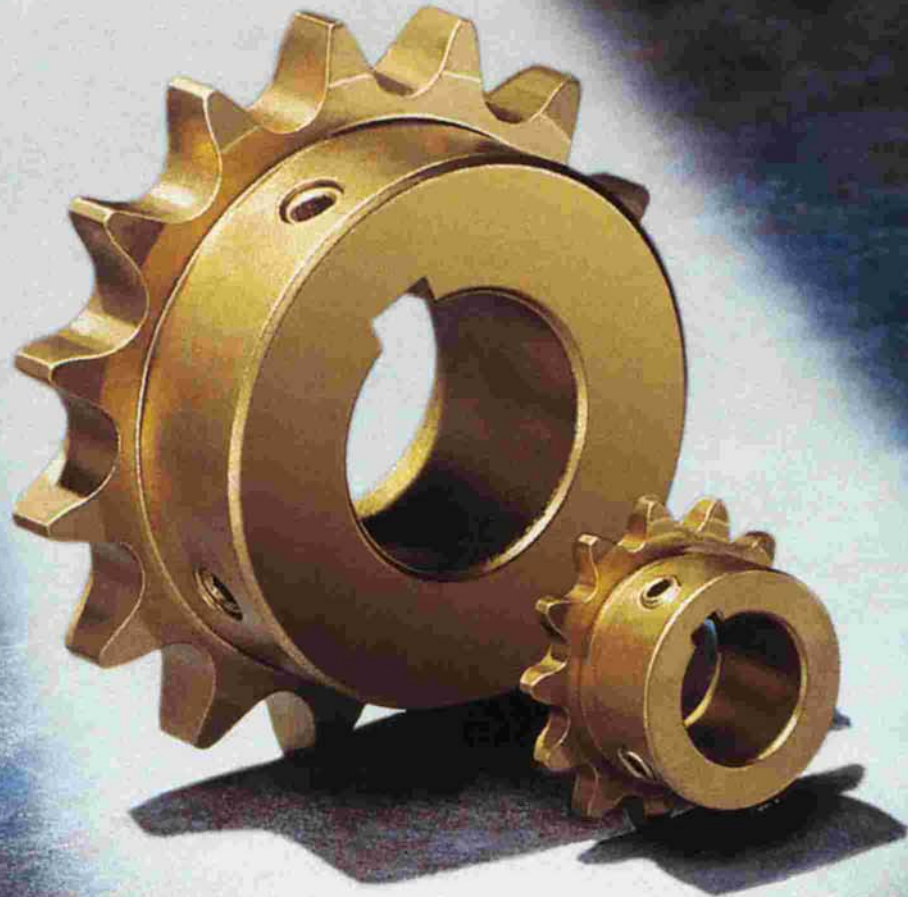

**Piñones
con agujero y chavetero**

**Piñones Taper
con dientes
endurecidos**



S
A
B
E
R
T
O
O
T
H
®



Piñones estándar

- Dimensiones y acabado según norma DIN 8187 ISO / R606.
- Calidad de Acero F-114.
- Pavonados color negro.

Equivalencias de material

UNE: F-1140

DIN: CK45

UNI: C45

BS: 080 M 46

AFNOR: XC45

AISI / SAE: 1045



Piñones dentados

PIÑONES DENTADOS 06B

Calidad, dimensiones y acabados según normas DIN-ASA-ANSI

Z	d _e	d _p	SIMPLE			DOBLE			TRIPLE		
			d _m	D ₁	A	d _m	D ₁	A	d _m	D ₁	A
8	28,0	24,89	15	6	22						
9	31,0	27,85	18	8	22						
10	34,0	30,82	20	8	22						
11	37,0	33,80	22	8	25	22	10	25			
12	40,0	36,80	25	8	25	25	10	25	25	12	35
13	43,0	39,79	28	10	25	28	10	25	28	12	35
14	46,3	42,80	31	10	25	31	10	25	31	12	35
15	49,3	45,81	34	10	25	34	10	25	34	12	35
16	52,3	48,82	37	10	28	37	12	30	37	12	35
17	55,3	51,83	40	10	28	40	12	30	40	12	35
18	58,3	54,85	43	10	28	43	12	30	43	12	35
19	61,3	57,87	45	10	28	46	12	30	46	12	35
20	64,3	60,89	46	10	28	49	12	30	49	12	35
21	68,0	63,91	48	12	28	52	12	30	52	14	40
22	71,0	66,93	50	12	28	55	12	30	54	14	40
23	73,5	69,95	52	12	28	58	12	30	58	14	40
24	77,0	72,97	54	12	28	61	12	30	61	14	40
25	80,0	76,00	57	12	28	64	12	30	64	14	40
26	83,0	79,02	60	12	28	67	12	30	67	14	40
27	86,0	82,05	60	12	28	70	12	30	70	14	40
28	89,0	85,07	60	12	28	73	12	30	73	14	40
29	92,0	88,09	60	12	28	76	12	30	76	14	40
30	94,7	91,12	60	12	30	79	12	30	80	14	40
31	98,3	94,15	65	14	30						
32	101,3	97,17	65	14	30	80	16	30	80	16	40
33	104,3	100,20	65	14	30						
34	107,3	103,23	65	14	30						
35	110,4	106,26	65	14	30	80	16	30	80	16	40
36	113,4	109,29	70	16	30	90	16	30	90	16	40
37	116,4	112,32	70	16	30						
38	119,5	115,35	70	16	30	90	16	30	90	16	40
39	122,5	118,37	70	16	30						
40	125,5	121,40	70	16	30	90	16	35	90	16	48

Piñón 3/8" x 7/32"

para cadena de rodillos
según DIN 8187-8188
ISO/R 606 - ANSI B. 29.1

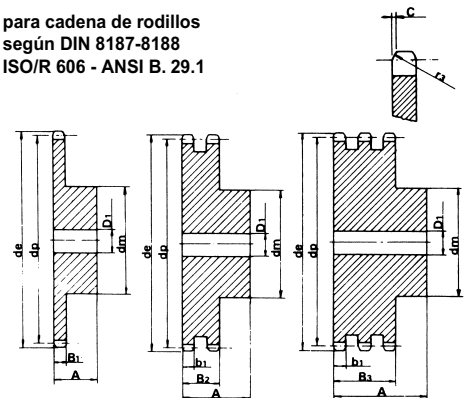

PIÑÓN	ISO mm	ASA-35 mm
Radio diente r ₃	10	10
Ancho radio C	1	1,2
Ancho radio piñón B ₁	5,3	4,3
Ancho radio piñón b ₁	5,2	4,1
Ancho radio piñón B ₂	15,4	14,3
Ancho radio piñón B ₃	25,6	24,4

CADENA	mm	mm
Paso	9,525	9,525
Ancho interior	5,72	4,77
Ø Rodillo	6,35	5,08

PIÑONES DENTADOS 08B

Calidad, dimensiones y acabados según normas DIN-ASA-ANSI

Z	d _e	d _p	SIMPLE			DOBLE			TRIPLE		
			d _m	D ₁	A	d _m	D ₁	A	d _m	D ₁	A
8	37,2	33,18	20	10	25						
9	41,0	37,13	24	10	25						
10	45,2	41,10	26	10	25	26	10	32			
11	48,7	45,07	29	10	25	30	11	35	30	14	50
12	53,0	49,07	33	10	28	35	12	35	34	14	50
13	57,4	53,06	37	10	28	38	12	35	38	14	50
14	61,8	57,07	41	10	28	42	12	35	42	14	50
15	65,5	61,09	45	10	28	46	12	35	46	14	50
16	69,5	65,10	50	12	28	50	14	35	50	16	50
17	73,6	69,11	52	12	28	54	14	35	54	16	50
18	77,8	73,14	56	12	28	58	14	35	58	16	50
19	81,7	77,16	60	12	28	62	14	35	62	16	50
20	85,8	81,19	64	12	28	66	14	35	66	16	50
21	89,7	85,22	68	14	28	70	16	40	70	20	55
22	93,8	89,24	70	14	28	70	16	40	70	20	55
23	98,2	93,27	70	14	28	70	16	40	70	20	55
24	101,8	97,29	70	14	28	75	16	40	75	20	55
25	105,8	101,33	70	14	28	80	16	40	80	20	55
26	110,0	105,36	70	16	30	85	20	40	85	20	55
27	114,0	109,40	70	16	30	85	20	40	85	20	55
28	118,0	113,42	70	16	30	90	20	40	90	20	55
29	122,0	117,46	80	16	30	95	20	40	95	20	55
30	126,1	121,50	80	16	30	100	20	40	100	20	55
31	130,2	125,54	90	16	30	100	20	40			
32	134,3	129,56	90	16	30	100	20	40			
33	138,4	133,60	90	16	30	100	20	40			
34	142,6	137,64	90	16	30	100	20	40			
35	146,7	141,68	90	16	30	100	20	40	110	20	55
36	151,0	145,72	90	16	35	110	20	40	120	25	55
37	154,6	149,76	90	16	35						
38	158,6	153,80	90	16	35	110	20	40	120	25	60
39	162,7	157,83	90	20	35						
40	166,8	161,87	90	16	35	110	20	45			

Piñón 1/2" x 5/16"

para cadena de rodillos según DIN 8187-8188 ISO/R 606 - ANSI B. 29.1

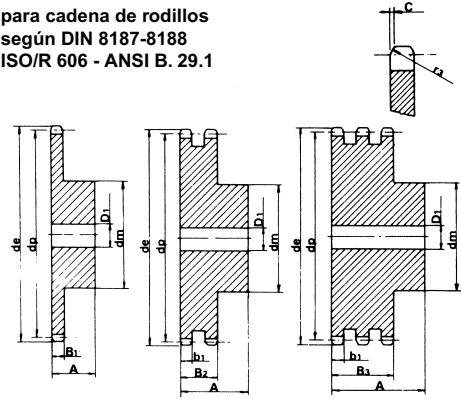

PIÑÓN	ISO mm	ASA-40 mm
Radio diente r ₃	13	13,5
Ancho radio C	1,3	1,6
Ancho radio piñón B ₁	7,2	7,2
Ancho radio piñón b ₁	7	7
Ancho radio piñón B ₂	21	21,4
Ancho radio piñón B ₃	34,9	35,8

CADENA	mm	mm
Paso	12,7	12,7
Ancho interior	7,75	7,94
Ø Rodillo	8,51	7,94

PIÑONES DENTADOS 10B

Calidad, dimensiones y acabados según normas DIN-ASA-ANSI

Z	d _e	d _p	SIMPLE			DOBLE			TRIPLE		
			d _m	D ₁	A	d _m	D ₁	A	d _m	D ₁	A
8	47,0	41,48	25	10	25						
9	52,6	46,42	30	10	25						
10	57,5	51,37	35	10	25						
11	63,0	56,34	37	12	30	37	14	40	37	16	55
12	68,0	61,34	42	12	30	44	14	40	43	16	55
13	73,0	66,32	47	12	30	49	14	40	48	16	55
14	78,0	71,34	52	12	30	53	14	40	53	16	55
15	83,0	76,36	57	12	30	59	14	40	58	16	55
16	88,0	81,37	60	14	30	63	16	45	63	16	60
17	93,0	86,39	60	14	30	69	16	45	68	16	60
18	98,3	91,42	70	14	30	73	16	45	73	16	60
19	103,3	96,45	70	14	30	79	16	45	79	16	60
20	108,4	101,49	75	14	30	84	16	45	84	16	60
21	113,4	106,52	75	16	30	85	16	45	85	20	60
22	118,0	111,55	80	16	30	90	16	45	90	20	60
23	123,4	116,58	80	16	30	95	16	45	95	20	60
24	128,3	121,62	80	16	30	100	16	45	100	20	60
25	134,0	126,66	80	16	30	105	16	45	105	20	60
26	139,0	131,70	85	20	35	110	20	45	110	20	60
27	144,0	136,75	85	20	35	110	20	45	110	20	60
28	148,7	141,78	90	20	35	115	20	45	115	20	60
29	153,8	146,83	90	20	35	115	20	45	115	20	60
30	158,8	151,87	90	20	35	120	20	45	120	20	60
31	163,9	156,92	95	20	35						
32	168,9	161,95	95	20	35	120	20	45	120	20	60
33	174,5	167,00	95	20	35						
34	179,0	172,05	95	20	35						
35	184,1	177,10	95	20	35	120	20	45	120	20	60
36	189,1	182,15	100	20	35	120	20	45	120	25	60
37	194,2	187,20	100	20	35						
38	199,2	192,24	80	20	40	120	20	45	120	25	60
39	204,2	197,29	100	20	35						
40	209,3	202,34	100	20	35	120	30	45			

Piñón 5/8" x 3/8"

para cadena de rodillos según DIN 8187-8188 ISO/R 606 - ANSI B. 29.1

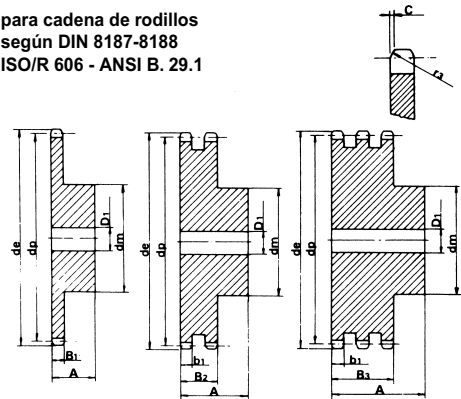

PIÑÓN	ISO mm	ASA-50 mm
Radio diente r ₃	16	17
Ancho radio C	1,6	2
Ancho radio piñón B ₁	9,1	8,7
Ancho radio piñón b ₁	9	8,4
Ancho radio piñón B ₂	25,5	26,5
Ancho radio piñón B ₃	42,1	44,6

CADENA	mm	mm
Paso	15,875	15,875
Ancho interior	9,65	9,52
Ø Rodillo	10,16	10,16

PIÑONES DENTADOS 12B

Calidad, dimensiones y acabados según normas DIN-ASA-ANSI

Z	d _e	d _p	SIMPLE			DOBLE			TRIPLE		
			d _m	D ₁	A	d _m	D ₁	A	d _m	D ₁	A
8	57,6	49,78	31	12	30						
9	62,0	55,70	37	12	30						
10	69,0	61,64	42	12	30	40	16	50			
11	75,0	67,61	46	14	35	47	16	50	47	20	70
12	81,5	73,61	52	14	35	53	16	50	53	20	70
13	87,5	79,59	58	14	35	59	16	50	59	20	70
14	93,6	85,61	64	14	35	65	16	50	65	20	70
15	99,8	91,63	70	14	35	71	16	50	71	20	70
16	105,5	97,65	75	16	35	77	20	50	77	20	70
17	111,5	103,67	80	16	35	83	20	50	83	20	70
18	118,0	109,71	80	16	35	89	20	50	89	20	70
19	124,2	115,75	80	16	35	95	20	50	95	20	70
20	129,7	121,78	80	16	35	100	20	50	100	20	70
21	136,0	127,82	90	20	40	100	20	50	100	20	70
22	141,8	133,86	90	20	40	100	20	50	100	20	70
23	149,0	139,90	90	20	40	110	20	50	110	20	70
24	153,9	145,94	90	20	40	110	20	50	110	20	70
25	160,0	152,00	90	20	40	120	20	50	120	20	70
26	165,9	158,04	95	20	40	120	20	50	120	20	70
27	172,3	164,09	95	20	40	120	20	50	120	20	70
28	178,0	170,13	95	20	40	120	20	50	120	20	70
29	184,1	176,19	95	20	40	120	20	50	120	20	70
30	190,5	182,25	95	20	40	120	20	50	120	20	70
31	196,3	188,31	100	20	40						
32	203,3	194,35	100	20	40	130	20	50			
33	209,3	200,40	100	20	40						
34	214,6	206,46	100	20	40						
35	221,0	212,52	100	20	40	130	20	50	130	25	70
36	226,8	218,58	100	20	40	130	25	50	130	25	70
37	232,9	224,64	100	20	40						
38	239,0	230,69	100	20	56	130	25	50	130	25	70
39	245,1	236,75	100	20	40						
40	251,3	242,81	100	20	40	130	25	50			

Piñón 3/4" x 7/16"

para cadena de rodillos según DIN 8187-8188 ISO/R 606 - ANSI B. 29.1

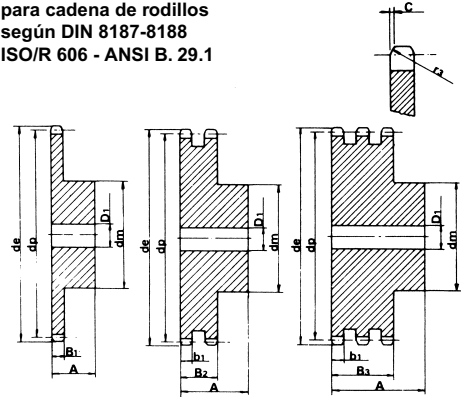

PIÑÓN	ISO mm	ASA-40 mm
Radio diente r ₃	19	20
Ancho radio C	2	2,4
Ancho radio piñón B ₁	11,1	11,6
Ancho radio piñón b ₁	10,8	11,3
Ancho radio piñón B ₂	30,3	34,1
Ancho radio piñón B ₃	49,8	56,9

CADENA	mm	mm
Paso	19,05	19,05
Ancho interior	11,68	12,7
Ø Rodillo	12,07	11,91

PIÑONES DENTADOS 16B

Calidad, dimensiones y acabados según normas DIN-ASA-ANSI

Z	d _e	d _p	SIMPLE			DOBLE			TRIPLE		
			d _m	D ₁	A	d _m	D ₁	A	d _m	D ₁	A
8	77,0	66,37	42	16	35						
9	85,0	74,27	50	16	35						
10	93,0	82,19	55	16	35	55	20	70			
11	99,5	90,14	61	16	40	63	20	70	63	25	100
12	109,0	98,14	69	16	40	72	20	70	72	25	100
13	117,0	106,12	78	16	40	80	20	70	80	25	100
14	125,0	114,15	84	16	40	88	20	70	88	25	100
15	133,0	122,17	92	16	40	96	20	70	96	25	100
16	141,0	130,20	100	20	45	104	20	70	104	30	100
17	149,0	138,22	100	20	45	112	20	70	112	30	100
18	157,0	146,28	100	20	45	120	20	70	120	30	100
19	165,2	154,33	100	20	45	128	20	70	128	30	100
20	173,2	162,38	100	20	45	130	20	70	130	30	100
21	181,2	170,43	110	20	50	130	25	70	130	30	100
22	189,3	178,48	110	20	50	130	25	70	130	30	100
23	197,5	186,53	110	20	50	130	25	70	130	30	100
24	205,5	194,59	110	20	50	130	25	70	130	30	100
25	213,5	202,66	110	20	50	130	25	70	130	30	100
26	221,6	210,72	120	20	50	130	25	70	130	30	100
27	229,6	218,79	120	20	50	130	25	70	130	30	100
28	237,7	226,85	120	20	50	130	25	70	130	30	100
29	245,8	234,92	120	20	50	130	25	70	130	30	100
30	254,0	243,00	120	20	50	130	25	70	140	32	105
31	262,0	251,08	120	25	50						
32	270,0	259,13	120	25	50	145	32	75			
33	278,5	267,21	120	25	50						
34	287,0	275,28	120	25	50						
35	296,2	283,36	120	25	50	145	32	75	140	32	105
36	304,6	291,44	120	25	50	145	32	80	140	32	105
37	312,6	299,51	120	25	50						
38	320,7	307,59	110	25	65	140	39	70	152	32	114
39	328,8	315,67	120	25	50						
40	336,9	323,75	120	25	50						

Piñón 1" x 17,02 mm

para cadena de rodillos según DIN 8187-8188 ISO/R 606 - ANSI B. 29.1

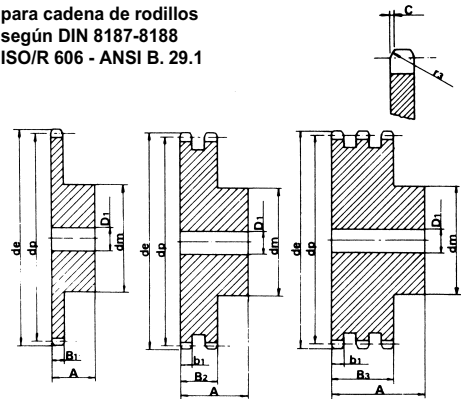

PIÑÓN	ISO mm	ASA-50 mm
Radio diente r ₃	26	27
Ancho radio C	2,5	3,2
Ancho radio piñón B ₁	16,2	14,6
Ancho radio piñón b ₁	15,8	14,1
Ancho radio piñón B ₂	47,7	43,4
Ancho radio piñón B ₃	79,6	72,7

CADENA	mm	mm
Paso	25,4	25,4
Ancho interior	17,02	15,88
Ø Rodillo	15,88	15,88

PIÑONES DENTADOS 20B

Calidad, dimensiones y acabados según normas DIN-ASA-ANSI

Z	d _e	d _p	SIMPLE			DOBLE			TRIPLE		
			d _m	D ₁	A	d _m	D ₁	A	d _m	D ₁	A
8	98,1	82,96	48	25	48						
9	108,0	92,84	58	25	48						
10	117,9	102,74	69	25	48	69	20	75	69	25	110
11	127,8	112,68	79	25	48	79	20	80	79	25	115
12	137,8	122,68	90	25	48	90	20	80	90	25	115
13	147,8	132,65	98	25	41	100	20	80	100	25	115
14	157,8	142,68	106	25	41	110	20	80	110	25	115
15	167,9	152,72	114	25	44	120	20	80	120	25	115
16	177,9	162,75	114	25	44	120	25	80	120	25	115
17	187,9	172,78	114	32	44	120	25	80	120	25	115
18	198,0	182,85	114	32	44	120	25	80	120	25	115
19	208,1	192,91	114	32	51	120	25	80	120	25	115
20	218,1	202,98	114	32	51	120	25	80	120	25	115
21	228,2	213,04	114	32	51	140	25	80	140	25	115
22	238,3	223,11	114	32	51	140	25	80	140	25	115
23	248,3	233,17	114	32	51	140	25	80	140	25	115
24	258,4	243,23	114	32	51	145	32	80	145	32	120
25	268,5	253,33	114	32	51	145	32	80	145	32	120
26	278,6	263,40	127	32	51	145	32	80	145	32	120
27	288,6	273,49	127	32	51	145	32	80	145	32	120
28	298,7	283,56	127	32	51	145	32	80	145	32	120
29	308,8	293,65	127	32	51						
30	318,9	303,75	127	32	51	145	32	80	145	32	120
31	329,0	313,85	127	32	51						
32	339,1	323,91	127	32	51	145	32	80	145	32	127
33	349,2	334,01	127	32	51						
34	359,3	344,10	127	32	51						
35	369,4	354,20	127	32	64	152	32	108	152	32	127
36	379,5	364,30	127	32	64	152	32	108	152	32	127
37	389,5	374,39	127	32	64						
38	399,6	384,49	127	32	64	152	32	114	152	40	127
39	409,7	394,59	127	32	64						
40	419,8	404,69	127	32	64	152	32	114	152	40	127

Piñones 1" 1/4 x 3/4"

para cadena de rodillos
s/ DIN 8187
ISO/R 606

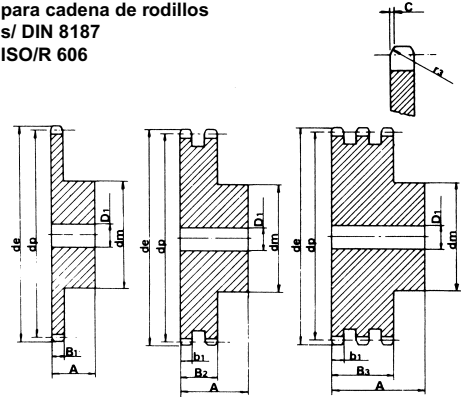

PIÑÓN mm

Radio diente r ₃	32
Ancho zona curva C	3,5
Ancho diente B ₁	18,5
Ancho diente b ₁	18,2
Ancho diente B ₂	54,6
Ancho diente B ₃	91

CADENA mm

Paso	31,75
Ancho interior	19,56
Ø Rodillo	19,05

PIÑONES DENTADOS 24B

Calidad, dimensiones y acabados según normas DIN-ASA-ANSI

Z	d _e	d _p	SIMPLE		
			d _m	D ₁	A
9	126,4	111,40	69	20	45
10	138,0	123,29	80	20	45
11	150,0	135,21	90	25	50
12	162,0	147,22	102	25	50
13	174,2	159,18	114	25	50
14	186,2	171,22	127	32	60
15	198,2	183,26	140	32	60
16	210,3	195,30	140	32	60
17	222,3	207,34	140	32	60
18	234,3	219,42	140	32	60
19	246,5	231,49	140	32	60
20	258,6	243,57	140	32	60
21	270,6	255,65	140	32	60
22	282,7	267,73	140	32	60
23	294,8	279,80	140	32	60
24	306,8	291,88	140	32	60
25	319,0	304,00	140	32	60
26	331,0	316,08	150	40	65
27	343,2	328,19	150	40	65
28	355,2	340,27	160	40	65
29	367,3	352,38	160	40	65
30	379,5	364,50	160	40	65
31	391,6	376,62	160	40	65
32	403,7	388,69	160	40	65
33	415,8	400,81	160	40	65
34	427,8	412,93	160	40	65
35	440,0	425,04	160	40	65
36	452,0	437,16	160	40	65
38	476,2	461,39	160	40	65

Piñones 1" 1/2 x 1"

para cadena de rodillos
s/ DIN 8187
ISO/R 606

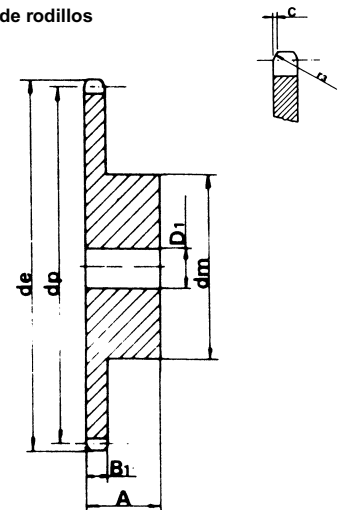

PIÑÓN mm

Radio diente r ₃	38
Ancho zona curva C	4
Ancho diente B ₁	24,1

CADENA mm

Paso	38,1
Ancho interior	25,4
Ø Rodillo	25,4

Le entregamos los piñones con el agujero acabado H7, chavetero y dos tornillos prisioneros a 90°.

Características

- Calidad, dimensiones y acabados según norma DIN 8187 ISO / R606.
- El chavetero está alineado con el diente.
- Fabricados en calidad de acero F-114.
- Pavonados color negro.



Equivalencias de material

UNE: F-1140
 DIN: CK45
 UNI: C45
 BS: 080 M 46
 AFNOR: XC45
 AISI / SAE: 1045

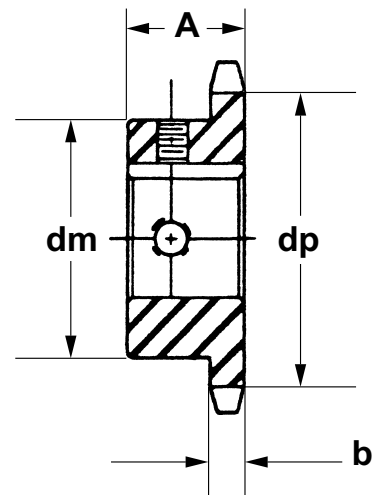

TIPO BS

06B-1

PASO

9.525 mm (3/8")

SIMPLE

Nº dientes	dp Diámetro prim.	A Ancho total	b Ancho diente	Agujeros en mm. Incluye chavetero y tornillos prisioneros
10	30,82	22	5,3	*10 - ^12 - ^14 - ^16
11	33,80	25	5,3	*10 - ^12 - ^14 - 16 - 19
12	36,80	25	5,3	*10 - *12 - 14 - 16 - 19
13	39,79	25	5,3	*10 - *12 - 14 - 16 - 19
14	42,80	25	5,3	*12 - 14 - 16 - 19
15	45,81	25	5,3	*12 - 14 - 16 - 19 - 20 - 22 - 24 - 25
16	48,82	28	5,3	*12 - 14 - 16 - 19 - 20 - 22 - 24 - 25
17	51,83	28	5,3	*12 - 14 - 16 - 19 - 20 - 22 - 24 - 25
18	54,85	28	5,3	*12 - 14 - 16 - 19 - 20 - 22 - 24 - 25
19	57,87	28	5,3	*12 - 14 - 16 - 19 - 20 - 22 - 24 - 25
20	60,89	28	5,3	*12 - 14 - 16 - 19 - 20 - 22 - 24 - 25
21	63,91	28	5,3	16 - 19 - 20 - 22 - 24 - 25
22	66,93	28	5,3	16 - 19 - 20 - 22 - 24 - 25
23	69,95	28	5,3	16 - 19 - 20 - 22 - 24 - 25
24	72,97	28	5,3	16 - 19 - 20 - 22 - 24 - 25
25	76,00	28	5,3	16 - 19 - 20 - 22 - 24 - 25

* Indica sin chavetero. Sólo tornillos prisioneros en agujero.

^ Indica chavetero con tornillo prisionero a 90 grados.

Los diámetros de los cubos varían según los diferentes agujeros.

08B-1

PASO

12.70 mm (1/2")

SIMPLE

Nº dientes	dp Diámetro prim.	A Ancho total	b Ancho diente	Agujeros en mm. Incluye chavetero y tornillos prisioneros
10	41,10	25	7,2	*12 - 14 - 16 - 19
11	45,07	25	7,2	*12 - 14 - 16 - 19 - 20 - 22
12	49,07	28	7,2	*12 - 14 - 16 - 19 - 20 - 22 - 24 - 25 - 28
13	53,06	28	7,2	*12 - 14 - 16 - 19 - 20 - 22 - 24 - 25 - 28
14	57,07	28	7,2	*12 - 14 - 16 - 19 - 20 - 22 - 24 - 25 - 28
15	61,09	28	7,2	*12 - 14 - 16 - 19 - 20 - 22 - 24 - 25 - 28 - 30 - 32
16	65,10	28	7,2	16 - 19 - 20 - 22 - 24 - 25 - 28 - 30 - 32
17	69,11	28	7,2	16 - 19 - 20 - 22 - 24 - 25 - 28 - 30 - 32
18	73,14	28	7,2	16 - 19 - 20 - 22 - 24 - 25 - 28 - 30 - 32 - 35 - 38
19	77,16	28	7,2	16 - 19 - 20 - 22 - 24 - 25 - 28 - 30 - 32 - 35 - 38
20	81,19	28	7,2	16 - 19 - 20 - 22 - 24 - 25 - 28 - 30 - 32 - 35 - 38
21	85,22	28	7,2	16 - 19 - 20 - 22 - 24 - 25 - 28 - 30 - 32 - 35 - 38
22	89,24	28	7,2	16 - 19 - 20 - 22 - 24 - 25 - 28 - 30 - 32 - 35 - 38
23	93,27	28	7,2	19 - 20 - 22 - 24 - 25 - 28 - 30 - 32 - 35 - 38
24	97,29	28	7,2	19 - 20 - 22 - 24 - 25 - 28 - 30 - 32 - 35 - 38
25	101,33	28	7,2	19 - 20 - 22 - 24 - 25 - 28 - 30 - 32 - 35 - 38

* Indica sin chavetero. Sólo tornillos prisioneros en agujero.
Los diámetros de los cubos varían según los diferentes agujeros.

10B-1

PASO

15.875 mm (5/8")

SIMPLE

Nº dientes	dp Diámetro prim.	A Ancho total	b Ancho diente	Agujeros en mm. Incluye chavetero y tornillos prisioneros
10	51,37	25	9,1	16 - 19 - 20 - 22 - ^24 - ^25
11	56,34	28	9,1	16 - 19 - 20 - 22 - 24 - 25 - 28 - 30
12	61,34	28	9,1	16 - 19 - 20 - 22 - 24 - 25 - 28 - 30 - 32
13	66,32	28	9,1	16 - 19 - 20 - 22 - 24 - 25 - 28 - 30 - 32
14	71,34	28	9,1	16 - 19 - 20 - 22 - 24 - 25 - 28 - 30 - 32
15	76,36	28	9,1	16 - 19 - 20 - 22 - 24 - 25 - 28 - 30 - 32 - 35
16	81,37	30	9,1	19 - 20 - 22 - 24 - 25 - 28 - 30 - 32 - 35 - 38
17	86,39	30	9,1	19 - 20 - 22 - 24 - 25 - 28 - 30 - 32 - 35 - 38
18	91,42	30	9,1	19 - 20 - 22 - 24 - 25 - 28 - 30 - 32 - 35 - 38
19	96,45	30	9,1	19 - 20 - 22 - 24 - 25 - 28 - 30 - 32 - 35 - 38 - 40 - 42
20	101,49	30	9,1	19 - 20 - 22 - 24 - 25 - 28 - 30 - 32 - 35 - 38 - 40 - 42
21	106,52	30	9,1	19 - 20 - 22 - 24 - 25 - 28 - 30 - 32 - 35 - 38 - 40 - 42
22	111,55	30	9,1	19 - 20 - 22 - 24 - 25 - 28 - 30 - 32 - 35 - 38 - 40 - 42
23	116,58	30	9,1	19 - 20 - 22 - 24 - 25 - 28 - 30 - 32 - 35 - 38 - 40 - 42
24	121,62	30	9,1	19 - 20 - 22 - 24 - 25 - 28 - 30 - 32 - 35 - 38 - 40 - 42
25	126,66	30	9,1	19 - 20 - 22 - 24 - 25 - 28 - 30 - 32 - 35 - 38 - 40 - 42

^ Indica chavetero con tornillo prisionero a 90 grados.
Los diámetros de los cubos varían según los diferentes agujeros.

12B-1

PASO

19.05 mm (3/4")

SIMPLE

Nº dientes	dp Diámetro prim.	A Ancho total	b Ancho diente	Agujeros en mm. Incluye chavetero y tornillos prisioneros
10	61,64	30	11,1	19 - 20 - 22 - 24 - 25 - 28 - 30 - 32
11	67,61	35	11,1	19 - 20 - 22 - 24 - 25 - 28 - 30 - 32
12	73,61	35	11,1	19 - 20 - 22 - 24 - 25 - 28 - 30 - 32 - 35 - 38
13	79,59	35	11,1	19 - 20 - 22 - 24 - 25 - 28 - 30 - 32 - 35 - 38
14	85,61	35	11,1	19 - 20 - 22 - 24 - 25 - 28 - 30 - 32 - 35 - 38 - 40
15	91,63	35	11,1	19 - 20 - 22 - 24 - 25 - 28 - 30 - 32 - 35 - 38 - 40
16	97,65	35	11,1	19 - 20 - 22 - 24 - 25 - 28 - 30 - 32 - 35 - 38 - 40
17	103,67	35	11,1	25 - 28 - 30 - 32 - 35 - 38 - 40 - 42
18	109,71	35	11,1	25 - 28 - 30 - 32 - 35 - 38 - 40 - 42
19	115,75	35	11,1	25 - 28 - 30 - 32 - 35 - 38 - 40 - 42 - 45 - 48 - 50
20	121,78	35	11,1	25 - 28 - 30 - 32 - 35 - 38 - 40 - 42 - 45 - 48 - 50
21	127,82	40	11,1	25 - 28 - 30 - 32 - 35 - 38 - 40 - 42 - 45 - 48 - 50
22	133,86	40	11,1	25 - 28 - 30 - 32 - 35 - 38 - 40 - 42 - 45 - 48 - 50
23	139,90	40	11,1	25 - 28 - 30 - 32 - 35 - 38 - 40 - 42 - 45 - 48 - 50
24	145,94	40	11,1	25 - 28 - 30 - 32 - 35 - 38 - 40 - 42 - 45 - 48 - 50
25	152,00	40	11,1	25 - 28 - 30 - 32 - 35 - 38 - 40 - 42 - 45 - 48 - 50

Los diámetros de los cubos varían según los diferentes agujeros.

16B-1

PASO

25.40 mm (1")

SIMPLE

Nº dientes	dp Diámetro prim.	A Ancho total	b Ancho diente	Agujeros en mm. Incluye chavetero y tornillos prisioneros
11	90,14	40	16,2	25 - 28 - 30 - 32 - 35 - 38 - 40 - 42
12	98,14	40	16,2	25 - 28 - 30 - 32 - 35 - 38 - 40 - 42
13	106,12	40	16,2	25 - 28 - 30 - 32 - 35 - 38 - 40 - 42 - 45 - 48 - 50
14	114,15	40	16,2	25 - 28 - 30 - 32 - 35 - 38 - 40 - 42 - 45 - 48 - 50
15	122,17	40	16,2	25 - 28 - 30 - 32 - 35 - 38 - 40 - 42 - 45 - 48 - 50
16	130,20	45	16,2	25 - 28 - 30 - 32 - 35 - 38 - 40 - 42 - 45 - 48 - 50
17	138,22	45	16,2	25 - 28 - 30 - 32 - 35 - 38 - 40 - 42 - 45 - 48 - 50
18	146,28	45	16,2	25 - 28 - 30 - 32 - 35 - 38 - 40 - 42 - 45 - 48 - 50
19	154,33	45	16,2	25 - 28 - 30 - 32 - 35 - 38 - 40 - 42 - 45 - 48 - 50
20	162,38	45	16,2	25 - 28 - 30 - 32 - 35 - 38 - 40 - 42 - 45 - 48 - 50
21	170,43	50	16,2	25 - 28 - 30 - 32 - 35 - 38 - 40 - 42 - 45 - 48 - 50
22	178,48	50	16,2	25 - 28 - 30 - 32 - 35 - 38 - 40 - 42 - 45 - 48 - 50
23	186,53	50	16,2	25 - 28 - 30 - 32 - 35 - 38 - 40 - 42 - 45 - 48 - 50
24	194,59	50	16,2	25 - 28 - 30 - 32 - 35 - 38 - 40 - 42 - 45 - 48 - 50
25	202,66	50	16,2	25 - 28 - 30 - 32 - 35 - 38 - 40 - 42 - 45 - 48 - 50

Los diámetros de los cubos varían según los diferentes agujeros.

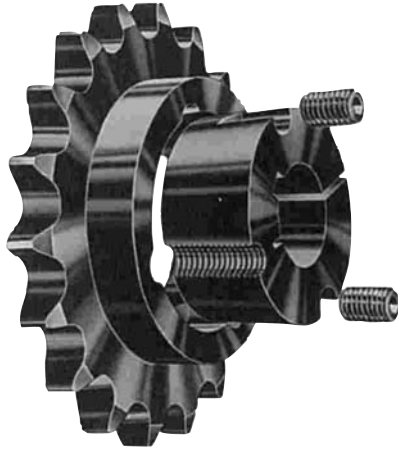

Material

Todos los piñones en existencia *Martin* están hechos de acero de calidad y con respecto a nuestras especificaciones.

Recomendaciones para Endurecimiento

Los dientes endurecidos incrementan substancialmente la vida del piñón y se recomiendan bajo las siguientes condiciones:

1. Piñón ó motriz donde la reducción sea de 4:1 ó mayor.
2. Transmisiones de velocidad lenta.
3. Donde el factor de seguridad sea menor que el estándar.
4. Condiciones abrasivas poco usuales.

Grado de endurecimiento - está determinado por las condiciones que prevalezcan en cada aplicación - Las siguientes sugerencias generales pueden ser utilizadas como guías para piñones en existencia:

1. Rockwell "C" 35 a 50 piñón ó motriz.
2. Rockwell "C" 25 a 40 en diámetros mayores o piñones motrices.

El endurecimiento por inducción ó por llama será utilizado como mejor convenga a cada aplicación individual. El diámetro y paso del piñón determinan el método a utilizar.

Deben tomarse precauciones para prevenir el "endurecimiento de lima" (Rockwell C 62 y mayor) ya que no se recomienda para piñones debido a su fragilidad.

La profundidad del endurecimiento debe estar limitada para proporcionar una cubierta sólo en las superficies de desgaste con un fondo elástico resistente para absorber el choque (Vea la ilustración de la sección de dientes).

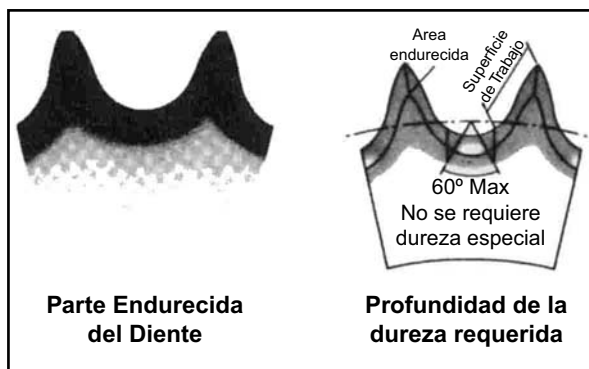

Nota: el endurecimiento no puede ser revisado correctamente con una lima - probadores de reforzamiento portátiles o estacionarios deben ser utilizados para resultados concluyentes.

Piñones Taper simples tratados por inducción

Nº dientes	06B1 (3/8")		08B1 (1/2")		10B1 (5/8")		12B1 (3/4")		16B1 (1")	
	Ø LW	TAPER BUSH	Ø LW	TAPER BUSH	Ø LW	TAPER BUSH	Ø LW	TAPER BUSH	Ø LW	TAPER BUSH
13	-	-	-	-	66,32	1008	79,59	1210	106,12	1615
14	-	-	-	-	71,34	1108	85,61	1610	114,15	1615
15	-	-	61,09	1008	76,36	1210	91,63	1610	122,17	1615
16	-	-	65,10	1108	81,37	1610	97,65	1610	130,20	2012
17	51,83	1008	69,11	1210	86,39	1610	103,67	1610	138,22	2012
18	54,85	1008	73,14	1210	91,42	1610	109,71	2012	146,28	2517
19	57,87	1008	77,16	1210	96,45	1610	115,75	2012	154,33	2517
20	60,89	1008	81,19	1610	101,49	1610	121,78	2012	162,38	2517
21	63,91	1008	85,22	1610	106,52	1610	127,82	2517	170,43	2517
22	66,93	1108	89,24	1610	111,55	1610	133,86	2517	178,48	2517
23	69,95	1210	93,27	1610	116,58	1610	139,90	2517	186,53	2517
24	72,97	1210	97,29	1610	121,62	2012	145,94	2517	194,59	2517
25	76,00	1210	101,33	1610	126,66	2012	152,00	2517	202,66	2517
26	79,02	1210	105,36	1610	131,70	2012	158,04	2517	210,72	2517
27	82,05	1210	109,40	1610	136,75	2012	164,09	2517	218,79	2517
28	85,07	1210	113,42	2012	141,78	2012	170,13	2517	226,85	2517
29	88,09	1210	117,46	2012	146,83	2012	176,19	2517	234,92	3020
30	91,12	1210	121,50	2012	151,87	2012	182,25	2517	243,00	3020
38	115,35	1210	153,80	2012	192,24	2012	230,69	2517	307,59	3020
45	136,55	1210	182,07	2012	227,58	2012	273,10	2517	364,13	3020
57	172,90	1210	230,53	2012	288,19	2012	345,82	2517	461,09	3020
76	230,48	1210	307,31	2012	384,15	2012	460,98	2517	614,63	3020
95	288,08	1210	384,10	2012	-	-	576,17	2517	-	-

Nº dientes	20B1 (1 1/4")		24B1 (1 1/2")		28B1 (1 3/4")		32B1 (2")	
	Ø LW	TAPER BUSH	Ø LW	TAPER BUSH	Ø LW	TAPER BUSH	Ø LW	TAPER BUSH
13	132,6	2012	168,4	2517	185,8	3020	212,3	3020
15	152,7	2517	183,3	2517	213,8	3020	244,3	3535
17	172,8	2517	207,3	3020	241,9	3020	276,5	3535
19	192,9	2517	213,5	3020	270,1	3020	308,6	3535
21	213	2517	255,6	3020	298,3	3020	340,8	3535
23	233,2	2517	279,8	3020	326,4	3020	373,1	3535
25	253,3	2517	304	3020	354,7	3020	405,6	3535
38	384,5	3020	*461,4	3030	*538,3	3535	*615,2	4040
57	576,3	3020	*691,6	3535	*806,9	4040	*922,3	4545

* Indica piñones Taper con cubo centrado Tipo C

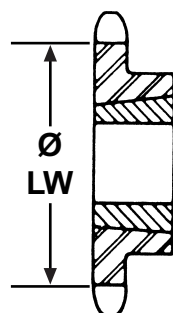

TIPO ESTANDAR

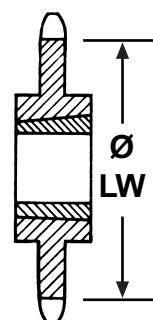

TIPO C

Piñones Taper duplex tratados por inducción

Nº dientes	06B2 (3/8")		08B2 (1/2")		10B2 (5/8")		12B2 (3/4")		16B2 (1")	
	Ø LW	TAPER BUSH	Ø LW	TAPER BUSH	Ø LW	TAPER BUSH	Ø LW	TAPER BUSH	Ø LW	TAPER BUSH
15	-	-	61,09	1008	76,36	1210	91,63	1610	122,17	2012
16	-	-	65,10	1108	81,37	1610	97,65	1610	130,20	2517
17	51,83	1008	69,11	1210	86,39	1610	103,67	1610	138,22	2517
18	54,85	1008	73,14	1210	91,42	1610	109,71	2012	146,28	2517
19	57,87	1008	77,16	1210	96,45	1610	115,75	2012	154,33	2517
20	60,89	1008	81,19	1610	101,49	1610	121,78	2517	162,38	2517
21	63,91	1008	85,22	1610	106,52	1610	127,82	2517	170,43	3020
22	66,93	1108	89,24	1610	111,55	1610	133,86	2517	178,48	3020
23	69,95	1210	93,27	1610	116,58	1610	139,90	2517	186,53	3020
24	72,97	1210	97,29	2012	121,62	2012	145,94	2517	194,59	3020
25	76,00	1210	101,33	2012	126,66	2012	152,00	2517	202,66	3020
26	79,02	1210	105,36	2012	131,70	2012	158,04	2517	210,72	3020
27	82,05	1210	109,40	2012	136,75	2012	164,09	2517	218,79	3020
28	85,07	1210	113,42	2012	141,78	2012	170,13	2517	226,85	3020
29	88,09	1210	117,46	2012	146,83	2012	176,19	2517	234,92	3020
30	91,12	1210	121,50	2012	151,87	2012	182,25	2517	243,00	3020
38	115,35	1610	153,80	2012	192,24	2012	230,69	3020	307,59	3020
45	136,55	1610	182,07	2012	-	-	273,10	3020	364,13	3030
57	172,90	1610	230,53	2012	-	-	345,82	3020	461,09	3020
76	230,48	1610	307,31	2012	-	-	460,98	3020	614,63	3020
95	-	-	384,10	2012	-	-	576,17	3020	768,22	4040

Piñones Taper triplex tratados por inducción

Nº dientes	12B3 (3/4")		16B3 (1")	
	Ø LW	TAPER BUSH	Ø LW	TAPER BUSH
17	103,67	2012	138,22	2517
19	115,75	2012	154,33	3030
21	127,82	2517	170,43	3030
23	139,90	2517	186,53	3535
25	152,00	2517	202,66	3535
27	164,09	3020	218,79	3535
30	182,25	3020	243,00	3535
38	230,69	3020	*307,59	3535
45	273,10	3020	*364,13	4040
57	345,82	3020	*461,09	4040
76	460,98	3020	*614,63	4040

* Indica piñones Taper con cubo centrado Tipo C

Dimensiones y características TAPER BUSH

Nº del casquillo cónico	Diámetro de eje disponible
1008	10-11-12-14-16-18-19-20-22-24-25
1108	10-11-12-14-16-18-19-20-22-24-25-28
1210	11-12-14-16-18-19-20-22-24-25-28-30-32
1610/1615	14-16-18-19-20-22-24-25-28-30-32-35-38-40-42
2012	14-16-18-19-20-22-24-25-28-30-32-35-38-40-42-45-48-50
2517	16-18-19-20-22-24-25-28-30-32-35-38-40-42-45-48-50-55-60
3020	25-28-30-32-35-38-40-42-45-48-50-55-60-65-70-75
3030	35-38-40-42-45-48-50-55-60-65-70-75
3535	35-38-40-42-45-48-50-55-60-65-70-75-80-85-90
4040	40-42-45-48-50-55-60-65-70-75-80-85-90-95-100
4545	55-60-65-70-75-80-85-90-95-100-105-110
5050	70-75-80-85-90-95-100-105-110-115-120-125

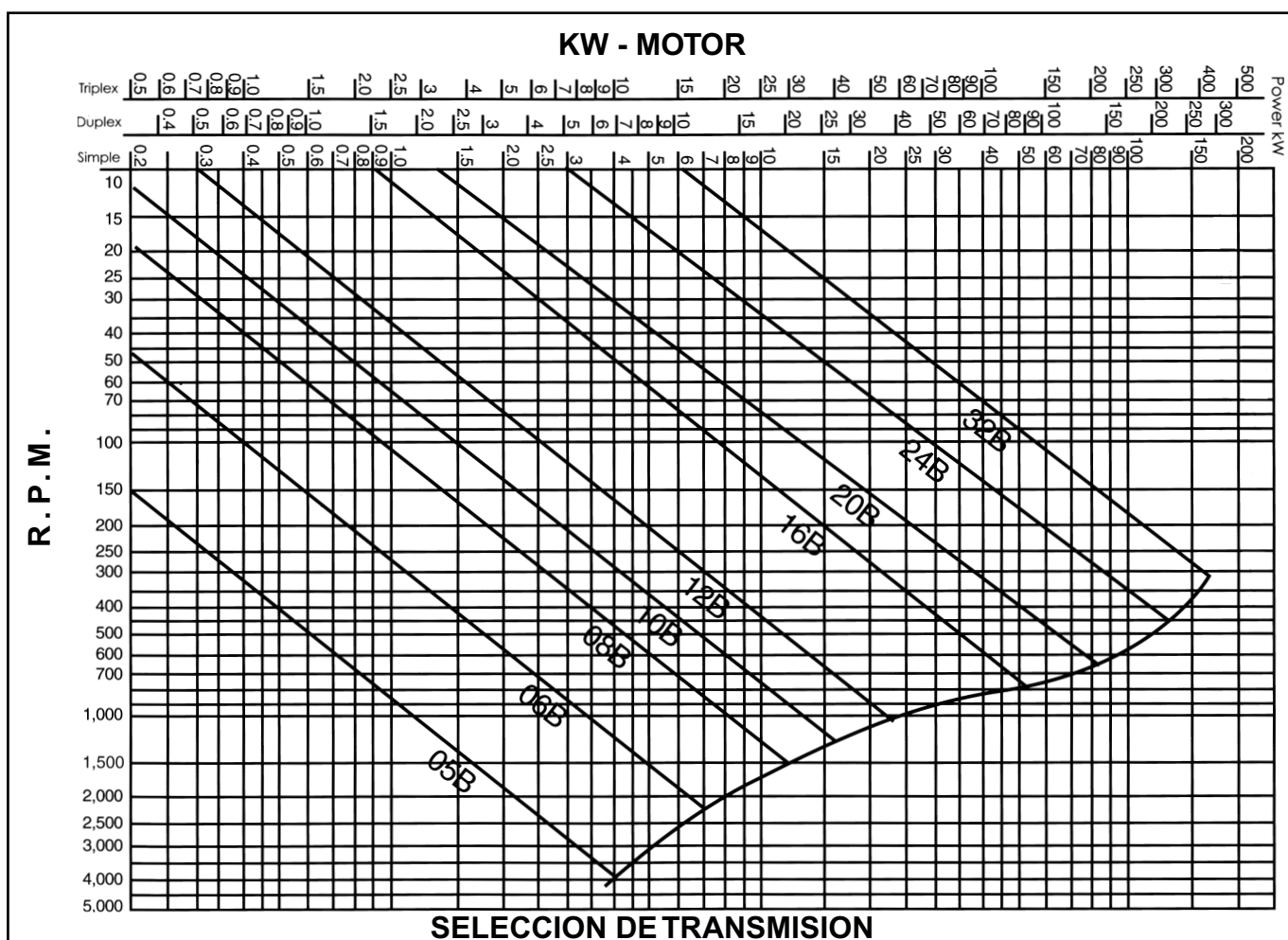

Dip. Legal: L-1287/01

Lindis, s.l.
LÍNEA INDUSTRIAL DE DISTRIBUCIONES

Sta. Joaquina de Vedruna, 3
Tel. 973 71 18 84
Fax 973 71 18 09
25230 MOLLERUSSA (Lleida)
E-mail: lindis@oem.es